

Liedtke GmbH

---

# **VisualRadio FALCON**

User Manual Version 7

VisualRadio FALCON 7

## **VisualRadio FALCON, Version 7**

### **User Manual**

Copyright 2003 – 2007 LIEDTKE GMBH

#### **Liedtke GmbH**

Computer Aided Monitoring

Sonnenweg 1

35708 Haiger

Germany

<http://www.visualradio.de>

Phone (+49) 2773 91 84 60

Fax (+49) ) 2773 7 45 08 87

email: [mail@visualradio.de](mailto:mail@visualradio.de)

## **Upgrades**

VisualRadio is continually refined and improved. As a result, there may be some differences between the descriptions in this manual and the version of the program you are using.

Microsoft, MS and MS-DOS are registered trademarks, Windows is a trademark of Microsoft Corporation in the USA and other countries.

IBM, AT and PS/2 are registered trademarks of International Business Machines, Inc.

All other trademarks or service marks are property of their respective owners.

No part of this document may be translated or reproduced or transmitted in any form or by any means, electronic or mechanical, for any purpose, without the express written permission of Liedtke GmbH.

# Contents

|   |           |
|---|-----------|
| <b>CONTENTSLICENSE AGREEMENT .....</b>                              | <b>3</b>  |
| <b>LICENSE AGREEMENT .....</b>                                      | <b>4</b>  |
| <b>OVERVIEW .....</b>   | <b>6</b>  |
| <b>THE DATABASE .....</b>   | <b>7</b>  |
| <b>SYSTEM REQUIREMENTS.....</b>                                     | <b>7</b>  |
| <b>INSTALLATION AND QUICK START .....</b>                           | <b>8</b>  |
| <b>A FEW WORDS OF ADVICE .....</b>                                  | <b>8</b>  |
| <b>SELECTING A DEVICE.....</b>                                      | <b>9</b>  |
| <b>CONNECTING MORE THAN ONE DEVICE TO VISUALRADIO .....</b>         | <b>9</b>  |
| <b>VISUALRADIO'S MENUS .....</b>                                    | <b>10</b> |
| <b>FILE.....</b>  | <b>10</b> |
| <b>VIEW.....</b>  | <b>13</b> |
| <b>DEVICES .....</b>  | <b>16</b> |
| <b>DF .....</b>   | <b>19</b> |
| <b>FIND .....</b>   | <b>22</b> |
| <b>DATABASE.....</b>  | <b>23</b> |
| <b>EXTRAS .....</b>   | <b>28</b> |
| LOAD AND GO.....  | 28        |
| CHAT .....  | 29        |
| CRYPT OPTIONS.....  | 29        |
| OPTIONS.....  | 30        |
| <b>FUNCTIONS SPECIFIC TO DIRECTION FINDERS.....</b>                 | <b>32</b> |
| <b>OUTPUT OF DIRECTION FINDERS DATA TO OTHER APPLICATIONS .....</b> | <b>32</b> |
| <b>SCANNING SECTORS (SEARCHING).....</b>                            | <b>36</b> |
| <b>RECORDER .....</b>   | <b>38</b> |
| <b>FREQUENCY DISPLAY AND RECEIVER SETTINGS.....</b>                 | <b>40</b> |
| <b>WRITE CHANNELSCAN VALUES .....</b>                               | <b>41</b> |
| <b>WRITE SECTORSCAN VALUES .....</b>                                | <b>41</b> |

**EXAMPLES** ..... **42**

    THE RECEIVER ..... 45

*Scenario A: 1 Computer In A Local Network*..... 45

*Scenario B: More Than One Computer In The Local Network* ..... 49

    THE AUDIO PART ..... 49

*Microsoft Media* ..... 49

    HOW TO BRING YOUR RECEIVER TO WAN/LAN AND INTERNET ..... 50

*How to deploy the dynamic IP*..... 50

*How to deploy the other parameters* ..... 50

**THE TCP/IP COMMAND SET** ..... **52**

## License Agreement

BY INSTALLING THE SOFTWARE, YOU ARE AGREEING TO BECOME BOUND BY THE TERMS OF THIS AGREEMENT, WHICH INCLUDES THE SOFTWARE LICENSE, LIMITED WARRANTY AND ACKNOWLEDGMENT.

IF YOU DO NOT AGREE TO THE TERMS OF THIS AGREEMENT, PROMPTLY RETURN THE CD AND THE HARDWARE ADAPTER FOR A FULL REFUND.

Liedtke GmbH grants you, the LICENSEE, a nonexclusive right to use VisualRadio, the SOFTWARE, on a single computer, i.e. with a single CPU, at a single location so long as you comply with the terms of this license. Liedtke GmbH reserves all rights not expressly granted to LICENSEE.

As the LICENSEE, you own the magnetic or other physical media on which the SOFTWARE is originally or subsequently recorded or fixed, but an express condition of this License is that Liedtke GmbH retains title and ownership of the SOFTWARE recorded on the original disk copies and all subsequent copies of the SOFTWARE. This license is not a sale of the original SOFTWARE or any copy.

This SOFTWARE and the accompanying written materials are the subject of copyrights. Unauthorized copying of the SOFTWARE, including SOFTWARE which has been modified, merged, or included with other software, or of the written materials is expressly forbidden.

As the LICENSEE, you may physically transfer the SOFTWARE from one computer to another provided that the SOFTWARE is used only on one computer at a time. You may not modify, adapt, translate, reverse engineer, decompile, disassemble, or create derivative works based on the SOFTWARE. You may not modify, adapt, translate or create derivative works based on the written material without the prior written consent of Liedtke GmbH.

In no event may you transfer, assign, rent, lease, sell or otherwise dispose of the SOFTWARE on a temporary or permanent basis except as expressly provided herein.

This License is effective until terminated. This License will terminate automatically without notice from Liedtke GmbH if you fail to comply with any provision of this License.

### LIMITED WARRANTY AND DISCLAIMER OF WARRANTY

The SOFTWARE and accompanying written materials are provided "AS IS" without warranty of any kind. Further, Liedtke GmbH does not warrant, guarantee or make any representations regarding the use, or the results of use, of the SOFTWARE or written materials in terms of correctness, accuracy, reliability, currentness, or otherwise. The entire risk as to the results and performance of the SOFTWARE is assumed by you. Liedtke GmbH warrants only the floppy disks for 12 month.

The above is the only warranty of any kind, either express or implied, including but not limited to the implied warranties of merchantability and fitness for a particular purpose. You may have other rights which vary from state to state.

Neither Liedtke GmbH nor anyone else who has been involved in the creation, production or delivery of this product shall be liable for any direct, indirect, consequential or incidental damages ( including damages for loss of business profits, business interruption, loss of business information, and the like ) arising out of the use or inability to use such product even if Liedtke GmbH has been advised of the possibility of such damages.

### ACKNOWLEDGMENT

You acknowledge that you have read this License and Limited Warranty, understand them, and agree to be bound by their terms and conditions. You also agree that the License and Limited Warranty are the complete and exclusive statement of agreement

between the parties and supersede all proposals or prior agreements, oral or written, and any other communications between the parties relating to the subject matter of the License or the Limited Warranty.

## Overview

VisualRadio is a software package to control Receivers/Transceivers and for the management of databases under Microsoft Windows. It uses databases that are compatible with Microsoft Access and thus guarantees long years of use as well as continual upgrades.

The underlying concept of VisualRadio enables you to learn and master the program quickly. VisualRadio can also be used in a Windows-compatible network environment.

There are also additional packages like TCP/IP support and VisualRadio Basic.

The program is easy to use and master. Data from your devices can be transferred into the database with a click of the mouse and is immediately accessible for tuning and further analysis. Database queries can be performed according to different criteria and combinations of criteria.

VisualRadio is unique in that it allows you to define new fields in the database and to quickly evaluate your databases in SQL-terms or to work with Microsoft Universal Data Access.

Additional functions, such as the automatic copying of broadcasts to hard disk or the scanning of channels at preset times, provide you with a wide range of possibilities for analyzing signals.

The ability to run unattended with user-defined triggers for recording audio, perform locally-controlled or remote, long-term scanning and intelligence collection functions are especially useful in professional surveillance applications.

VisualRadio is compatible with the highest-quality professional caliber receivers from Cubic Communications, Rohde & Schwarz, but also supports devices made by AOR, ICOM etc.

Since VisualRadio uses the same GUI for all receivers, you don't lose time getting reacquainted with the program when you install a new receiver from another manufacturer.

The package is continually upgraded to accommodate new receivers and transceivers.

## Special Features

VisualRadio's special features include the following:

- Controls up to 8 radios concurrently, more on special order
- VisualRadio can be used in a Windows-compatible network environment and - in it's Server version - over TCP/IP to control equipment worldwide
- Receiver tuning via double click on the corresponding data in a table or on the desired frequency in a graphic display
- Automatic identification of stations at tuned frequencies
- Synchronization of channeltables during tuning
- Unlimited number of Microsoft Access compatible databases
- Unlimited number of user defined tables
- Additional - user defined - fields can always be added to tables
- Easy filtering of tables by using SQL queries
- Provision for storing SQL queries into the database for later use
- Sorting of tablefields by a mouseclick

- All data in all columns of all tables can be searched and replaced
- Frequencies, mode of operation etc. will be easily transferred to the current Channeltable by a mouseclick
- Automatic recording of broadcasts in Windows WAV format
- Powerfull database analysis according to customized criteria
- Visualization tools like multiple scales (dBm, dBmV, dB $\mu$ V, mV RMS, mV Peak and S-Units) and spectra
- Support for **WAVECOM** W41PC/W51PC
- Separate GPS Server with provision for up to 20 clients
- **Digital Scan with VisualRadio Blackbird**
- Extensible by **VisualRadio Basic**

## The Database

VisualRadio is based on a Microsoft Access database.

Following installation of the program you have access to a database with the file name "VRADIO32.MDB" which contains the following types of tables:

|                          |   |
|--------------------------|---|
| <b>Channeltable</b>      | Table with channel scan frequencies                 |
| <b>Sectortable</b>       | Table with sector frequencies                       |
| <b>Memorytable</b>       | Table with receiver memories                        |
| <b>Channelscanvalues</b> | Signal strengths of channel scans                   |
| <b>Sectorscanvalues</b>  | Signal strengths of F1->F2 scans                    |
| <b>Sessiontables</b>     | Pointers to wave and trace data of spectrum devices |

By using the function 'New...' you create new tables of the above listed types at any time. Thus you can create channeltables for certain stations, sector scan tables with specified ranges, various receiver memory tables with selected stations (Aero, Utility) etc.

In addition, VisualRadio allows you to automatically create complete new databases that fit your own needs.

## System Requirements

VisualRadio requires

- a Pentium or higher processor at 300 MHz, Pentium III is recommended
- a mouse
- at least 128 MB RAM, 256 MB or more are recommended
- a free COM port or IEEE-4880 port for the devices, possibly a free slot in your computer to hold

internal cards like WAVECOM or Winradio

- Microsoft Windows 98 or higher

## Installation and Quick Start

- Connect the radio equipment to a free serial or IEEE-488 port. In case of cards like Winradio install the card first and run the manufacturers software.
- Connect the hardware adapter to a parallel or USB port and, in case of a parallel adapter, the printer to the other side of the adapter
- Place the CD-ROM into the drive, installation will start automatically
- Follow the instructions on the screen. If the radio should not connect to the program check the connection between radio and computer and also check that the proper cable type is used.. Make sure that no other program is using this port. If you are familiar with you may check the data transfer with a terminal program like "Hyper Terminal".

## A Few Words of Advice

VisualRadio is a powerful tool - To ensure that VisualRadio works for you, you should observe the following simple rules:

- Since the database functions apply to the table that is in use, always activate the table which you wish to use with a click of the mouse
- New entries in a table are highlighted until the data is saved to the database. To complete an entry, the cursor must be moved to the line above or the line below the entry
- To make frequency entries click on the frequency display - or press 'Strg Y' - and use the keyboard to enter the frequency. After typing the desired frequency press 'Return'
- To modify the mode of operation press 'Strg M'. Use the 'Tabulator' key to move from option to option



If a known entry cannot be found in a table press this button in the Control Panel to remove any filters or use 'Find -> Remove Filter'



If your computer and receiver are linked, the continuous communication between computer and receiver can cause your computer to respond slowly. To maintain the speed of your computer press this button or F7 to separate the receiver from the computer



If you are not quite sure what to enter into some of the data fields -- just press the transfer key and check the entries in the corresponding table



Use the function 'Find/Replace' to fill empty fields in a table - e.g. 'Mode' - with a global value.

## Selecting a Device

To select a device making it the current receiver

1. Connect all devices, i.e. press 'F7' or 'Devices → Remote On' or press the 'Connect' button in the toolbar
2. Click on the devices numeric button in the toolbat or
3. Doubleclick the devices 'Frequency/Level Window', i.e. the small blue window
4. Select 'Devices -> Main Receiver' and then select the receiver of interest

## Connecting more than one device to VisualRadio

If more than one device is to be used with VisualRadio, the following guidelines should be followed

VisualRadio provides the user with an interactive mechanism to define the relationship between devices and their associated tables.

The only place to define this relationship is the 'Scanner' Panel

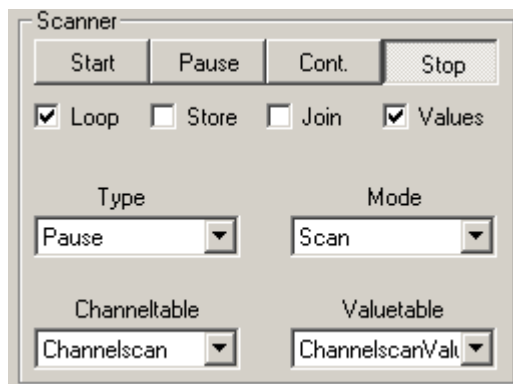

**The contents of boxes 'Channeltable' and 'Valuetable' in Mode 'Scan' define the currently active tables for the current main-device.**

**Also, the contents of boxes 'Sectortable' and 'Valuetable' in Mode 'Search' define the corresponding tables for the search. The same holds for the 'Sessionables' of spectrum devices.**

The following guidelines apply

1. Connect all devices
2. Select mode 'Scan' from the 'Mode' box
3. Select the appropriate Channeltable from the box 'Channeltable'
4. Select the appropriate Valuetable from the box 'Valuetable'
5. Change mode to 'Search' and do 1 – 4 for search mode

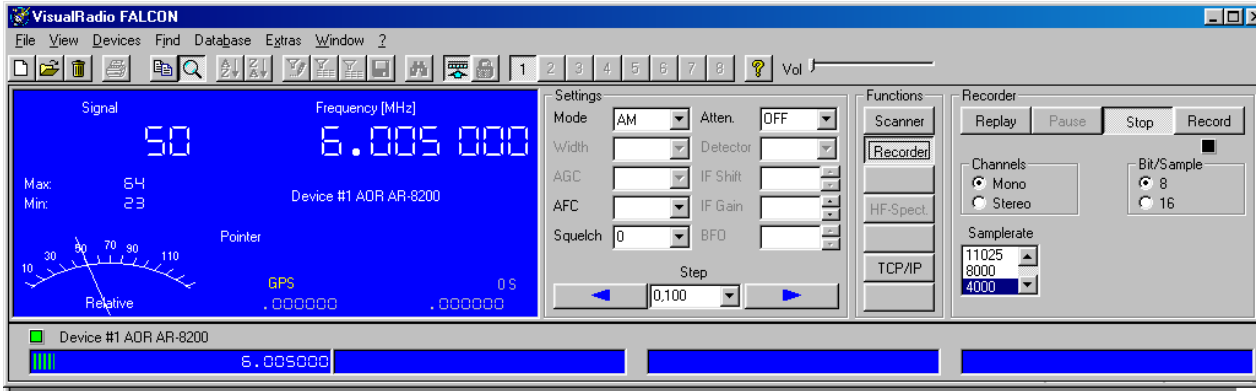

## VisualRadio's Menus



**Note:** Not all menus might be available with the version of VisualRadio you use.

## File

### **New**



This menu is used to create new tables in a database and to create new databases with automatically generated basic tables.

### ***New Database...***

Automatically creates a new database with empty basic tables. To use the database choose the name of the new database in the menu 'File Open Database'. Note that you can open only one database at a time, but that you can create an unlimited number of databases and use them successively.

### ***New Channeltable...***

This menu adds a new (empty) Channeltable to your database.

### ***New Sectortable...***

This menu adds a new (empty) Channeltable to your database.

### ***New Sessiontable...***

This menu adds a new (empty) Sessiontable to your database.

***New Channelvaluetable...***

This menu adds a new (empty) Channelvaluetable to your database.

***New Sectorvaluetable...***

This menu adds a new (empty) Sectorvaluetable to your database.

To work with a newly created table, choose the table by using the menu 'Open'.

***Open******Open Database...***

This function opens a new database that was created by using the function 'File New Database...'. Since VisualRadio can create and be applied to an unlimited number of databases, the number of databases is not limited.

Because VisualRadio can also be operated in a network environment, this menu can also be used to determine a network directory.

***Open Channeltable...***

This table is used for entering parameters such as discrete frequencies and tuning intervals. If you do not wish to perform a continuous scan you must make entries in the fields 'Dwelltime' and 'Signal'..

***Open Sectortable...***

This table is also used for entering parameters such as startfrequencies, stopfrequencies and tuning intervals.

***Open Channelvaluetable...***

This menu displays the current Channelvaluetable and allows you to analyze the settings.

***Open Sectorvaluetable...***

This menu displays the current Sectorvaluetable and allows you to analyze the settings.

***Open Sessiontable...***

This menu displays the current Sessiontable of the current receiver.



**Note:** Since version 2.1 you may define two or more devices to use the same tables.

In case of Channeltables two or more devices are supplied their parameters by the same table. This eliminates the use of different tables with the same contents.

## **Delete**



Menu for deleting tables. Tables may only be deleted if no devices are connected, i.e. VisualRadio does not control any radio. To delete a table, first use 'F7' to disconnect all devices.

### **Delete Channeltable...**

Deletes the selected Channeltable.

### **Delete Sectortable...**

Deletes the selected Sectortable.

### **Delete Sessiontable...**

Deletes the selected Sessiontable

### **Delete Channelvaluetable...**

Deletes the selected Channelvaluetable.

### **Delete Sectorvaluetable...**

Deletes the selected Sectorvaluetable

### **Print Setup...**

Printer setup

### **Print**

This function prints the tables and their contents. The layout is exactly the tables layout.

### **Exit**

Disconnects all devices, closes tables and database and exits

## View

Menu to toggle the visibility of

- **Debug Window** : Displays communication of active device, i.e. 'Main Receiver'
- **All Devices** : Displays the sub-receivers windows
- **Control Panel** : The Control Panel represents the interface to your receiver. It contains

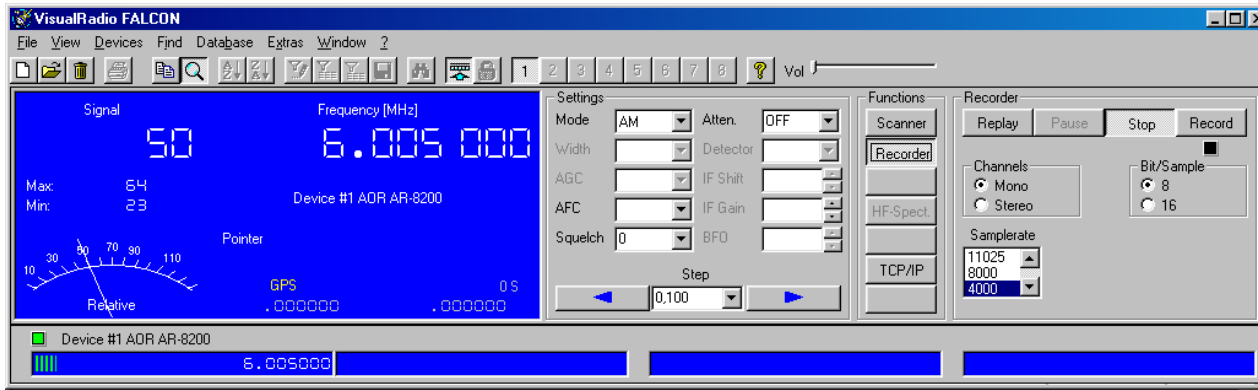

1. Signal displays for main and sub receivers, in case of a direction finder there are also the indicators for 'Bearing' and 'Quality'
2. Frequency displays for main and sub receivers
3. Receiver settings - Mode, Agc etc. for the main receiver
4. The Function Panel to display the Scanner, Recorder, HF-Spectrum and connected clients (TCP/IP)

When used with 600x800 resolution the panel automatically resizes

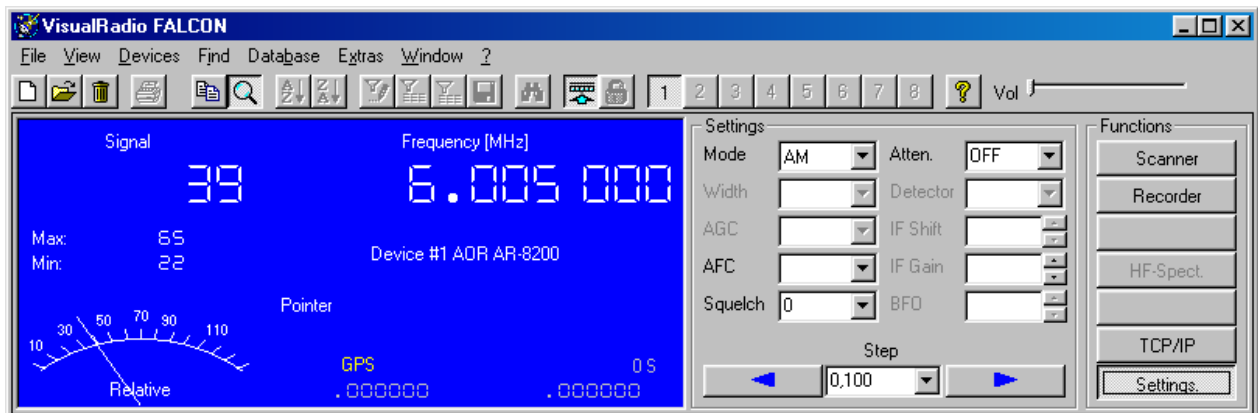

and the additional function panels like 'Scanner', 'Recorder' are displayed in place of the original 'Settings' panel, i.e. panels are 'stacked'

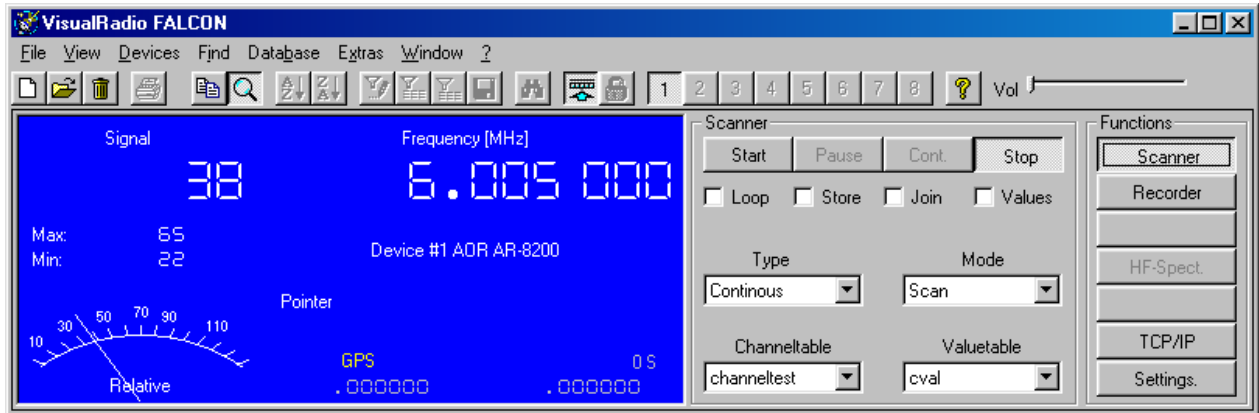















The Control Panel also contains the 'Functions' Panel to access

The Scanner, the Recorder and the TCP/IP Panel, which displays connected clients in form of their IP-address

- **Statusbar** : The Statusbar displays information about program status as well as date/time
- **Toolbar** : Hides/reveals the toolbars. VisualRadio uses 3 toolbars



-  Creates a new database or new tables in an existing database
-  Opens a new database or tables in an existing database
-  Deletes tables in a database
-  Prints tables
-  Transfers receiver parameters to the current Channeltable
-  Identifies the tuned station
-  Sorts the activated field in the current table in ascending order
-  Sorts the activated field in the current table in descending order
-  Displays the window for defining filters in the activated table
-  Applies the last filter that was used
-  Removes any filters from the activated table
-  Stores an SQL query
-  Searches/replaces in the activated field within a table
-  Opens and closes the interface



Locks receiver - if possible

1

Selects the corresponding radio

The buttons numbered 1...8 select the current receiver

Some versions might also have the following 3 buttons added to the main toolbar



1. Display DF's Histogram
2. Start Replay of DF's Histogram
3. Stop Replay of DF's Histogram

The slider 'Volume' allows for the control of the audio if available.

## **Devices**

This menu provides access to the various devices

### ***Main Receiver***

Selection of the main-receiver

### ***Set Frequency***

Tunes the main-receiver

### ***Set Mode***

Select detection mode of the main-receiver

### ***Lock Receiver***

Locks the current receiver

### ***Mute Receiver***

Toggles audio of main-receiver

### ***Suspend Receiver***

Temporarily toggles activity of the current receiver

### ***Signal Units***

In case of calibrated radios select dBm, dBmV, dB $\mu$ V, mV RMS, mV Peak or S-Units for display of the signal level

### ***Configure...***

Started for the first time, VisualRadio will automatically display the window below. It may be accessed any time by selecting 'Devices -> Configure' if the radios are not connected to the software.

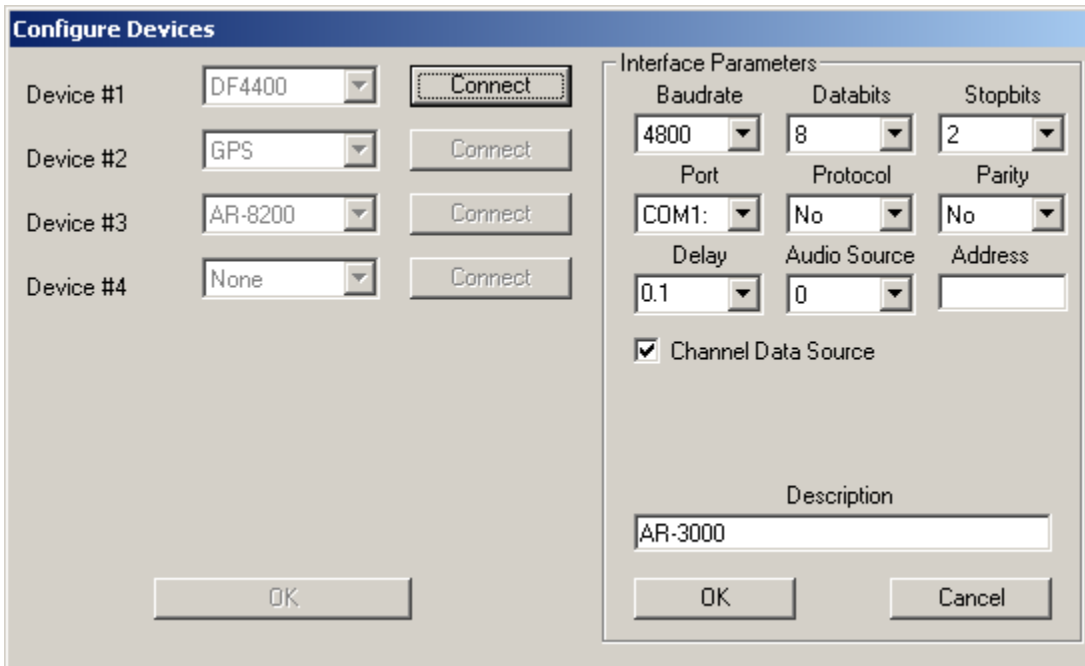

- Corresponding to the version ordered, one to eight devices may be controlled concurrently - special versions allow for more.
- Depending on the type of interface either the RS232C-, LAN-, IEEE- or BUS menu will show up
- Select the appropriate parameters for each radio and press 'OK' in the 'Interface Parameters' field. The contents of the 'Description' field will later be displayed beneath the small sub-receiver windows which display their frequency and signal
- Click the left button 'OK'
- In the main window press 'F7', select 'Devices On/Off' or click the 'Connect Devices' button - VisualRadio will create a link between your computer and the radio and the radio's parameters will be displayed
- The contents of the 'Delay' field determine the time between subsequent commands. In case of radios supplying an 'Operation Complete' message, this field could be set to '0'



**Starting with version 2.1 the properties 'Audio Source' and 'Channel Data Source' have been added to each device.**

**Property 'Audio Source' determines whether the corresponding radio delivers audio output to the recorder used: a value greater '0' makes the device the source. If you select another device as the 'Audio Source', the former will automatically reset to '0'.**

**The 'Channel Data Source' property, if set, enables 'Database -> Save to Table' and its button in the main toolbar. So only devices with this property checked will be able to store their values to their channeltable.**

VisualRadio FALCON 7

If a link is not created, check the connection between radio and computer, the wiring and the data transfer using a terminal program such as Windows 'Terminal'.

### ***On/Off***

Connect/Disconnect the radios

# DF

Menu to operate the Direction Finder

## Bearings Display

Brings up the bearings display with visual indicators for bearing, signal level and signal quality



## DF-Histogram

Displays the DF's bearings histogram over time during signal acquisition. The data is stored to the DF's Channelvalue table

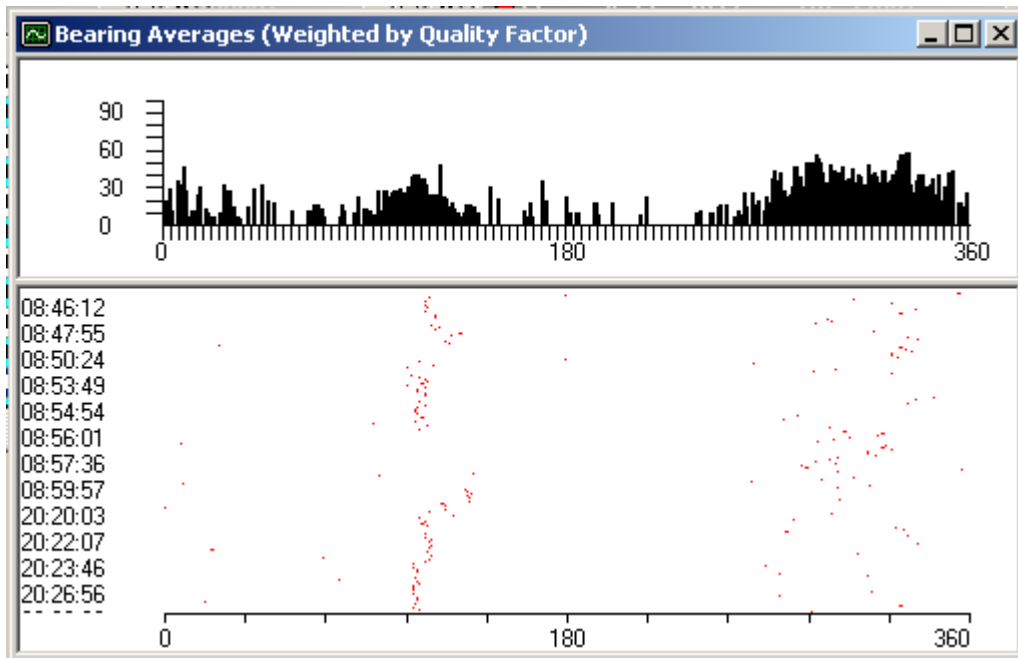

### Manual Identification...

If checked, allows input of manual identification of SOI to be stored into the devices Channel-valuetable. If this submenu is unchecked, the system uses the current ID of the devices Channeltable

### Control Settings...

Submenu to control the most important parameters of the DF.

In case of the CUBIC DF-4409

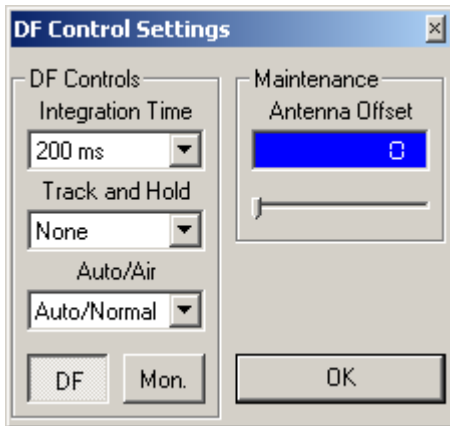

and for the Delphin Systems MD403

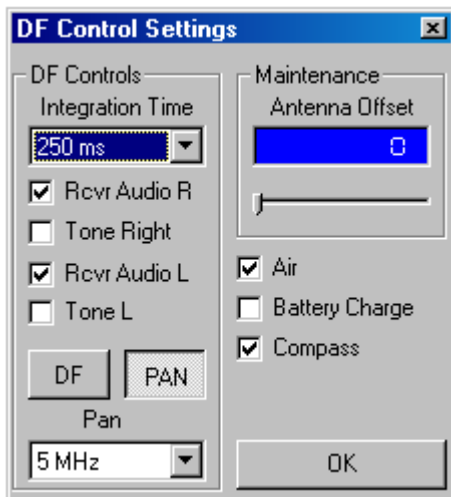

To specify the Antenna Offset the user might either use the slider or manually enter the offset.

A doubleclick with the left mouse button on the Bearings display will also bring up the 'Control Settings' menu-

## **Replay Histogram**

Replays the DF's histogram of bearing data from.

**The table may be filtered and/or sorted by means of SQL statements**



## **Stop Replay**

Stops replay of the histogram.

## Find

Menu to find stations and frequencies in the main-receivers channeltable.

### ***Find Station***



VisualRadio offers two means for finding stations:

Click the icon or select 'Find -> Station'. The current Channeltable will display the station related to the current frequency - if already included in the table- ; if not you can now store the data. The name of the station will be displayed below the frequency.

Tune your receiver manually. The name of the station will be displayed below the frequency.

### ***Other Frequencies***

The current Channeltable is filtered to display other frequencies of the same stations.

### ***Other Stations***

The current Channeltable is filtered to display other stations on the same frequency.

### ***Remove Filter***

Removes any filters from the database.

## Database

Menu to manipulate the database

### Open

This function displays the structure of the currently open database.

Since VisualRadio can be operated in a network environment, this menu can also be used to determine a network directory.

The structure of the database is displayed along with its location as follows:

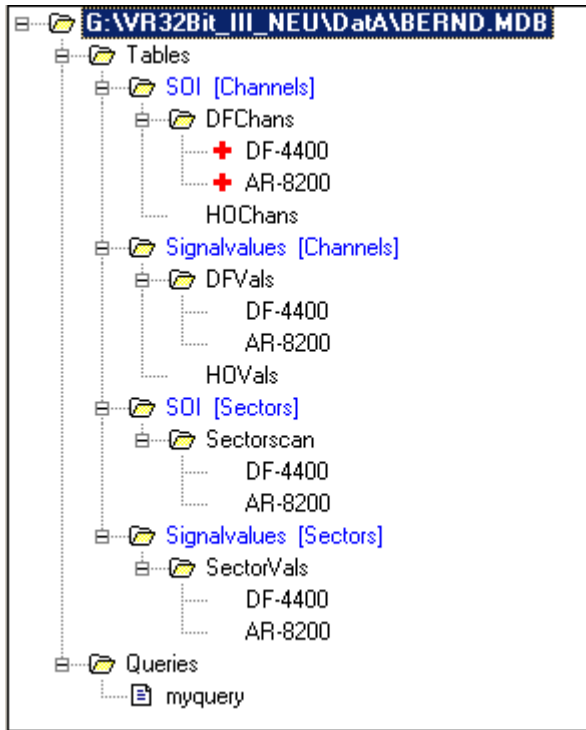

- **Tables** Displays all tables contained in the database
- **SOI (Channels)** All channeltables with Signals of Interest (SOI)  
The above database contains 2 channeltables, i.e. 'DFChans' and 'HOChans'. To display the table click its name.
- **RED PLUS** Indicates mode of operation for devices, i.e. 'Scan' or 'Search'. The example uses both devices in mode 'Scan' with table 'DFChans' as the source for both, 'HOChans' is not used but contained in the database
- **Device Name** Devices 'AR-8200' and 'DF-4400' are used
- **Signalvalues (Channels)** Lists the names of the valuetables for scanning, the example has both devices tied to 'DFVals', table 'HOVals' is not used for storing results
- **SOI (Sectors)** As for Channels
- **Signalvalues (Sectors)** As for Channels
- **Queries** Lists the user-defined queries

### **Sort Ascending**

In an active table VisualRadio can sort each field. Click on the field you want to sort



sorts ascending A to Z

### **Sort Descending**

In an active table VisualRadio can sort each field. Click on the field you want to sort



sorts descending Z to A



displays the original order of the table

## SQL Editor

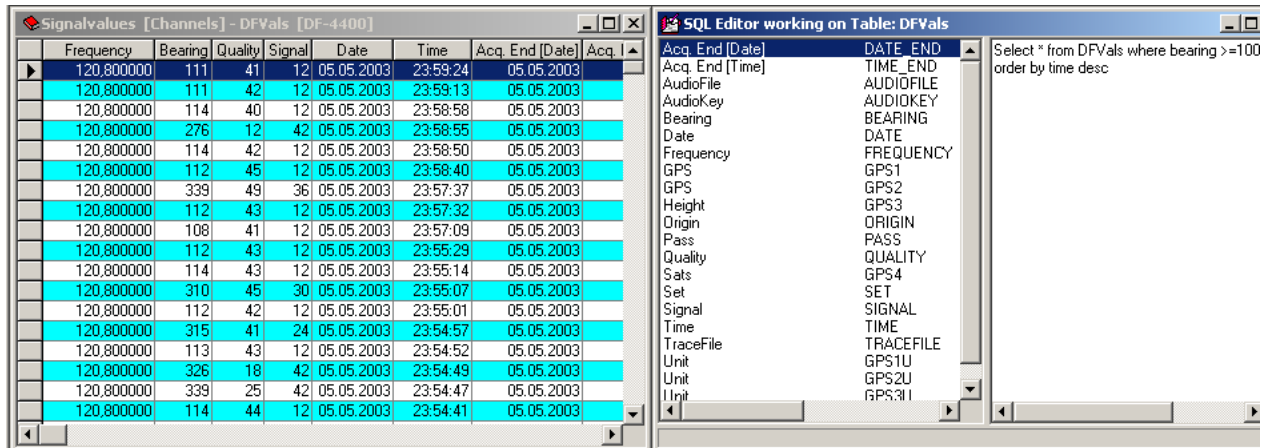

Version 2.1 and above use a new SQL Editor. Open any table and choose 'Database -> SQL Editor'. Then input your query and press the button 'Filter' or choose 'Database -> Apply Filter'. The SQL Editor works on the **current active table**. The caption of each column and the corresponding design-time definition are displayed in a list to the left. If you would like to filter the table for 'Acq. End' you should use its definition, i.e. 'DATE\_END'.



**Do not forget to activate the corresponding table before you apply the SQL statement**

The query can be modified and restarted at any time by clicking on the 'Query' button. To avoid having to recreate or modify queries each time you wish to use it, the queries can be saved in the database by clicking the 'Save' button.

If you later want to perform a query automatically, simply open the 'Queries' folder in the database representation and double-click the desired query.

### Apply Filter

Applies the SQL statement.

### Save Query

Stores the SQL statement to the database.

### Find/Replace

Finds and replaces items in the currently active table.

To activate all entries in the field 'Active' in a new table:

- Activate the table with a mouse click
- Click on the field 'Active'
- Select 'Database -> Find/Replace', press 'Strg H' or click on the symbol on the tool bar
- Type a '0' in the field 'Search for:' and a '-1' in the field 'Replace with:'
- Press the button 'Replace All'

### **Important!**



**When searching for or replacing logical operators, i.e. 'True' or 'False', 'True' or 'Yes' is always represented by '-1' and 'False' or 'No' is always represented by '0'.**

**VisualRadio also has a 'Transaction Tracking' function. This allows you to restore changes made to a number of entries in dialogue with the program.**

**To accept a change press 'Yes'. When 'Compare whole field' is activated, the whole content of a field is compared. The text box for 'Search' as well as the box for 'Replace' may be empty. Thus you can replace all empty 'Signal' fields with '-100'.**

### ***Falcon Layout***

Some versions allow for a user defined default layout. VisualRadio FALCON creates an empty directory, called 'Layouts', under its data directory. To revert the tables layout to this default layout

1. Size and place the tables as requested
2. Close VisualRadio
3. Copy all files with extension '.grx' from VisualRadio's program directory to the 'Layouts' directory

### ***Original Layout***

If, e.g. you have lost a field in a table by making the column containing it too narrow, you can restore the original format by clicking the button for this table in the menu 'Database -> Original Layout'.

### ***Save to Table***

Saves the main-receivers settings to the current channeltable.

### ***Save to All Tables***

Saves the main-receivers settings to all of the the current receivers tables.

**The settings will only be written to the table if the device is a 'Channel Data Source' as defined per 'Devices -> Configure'**

### ***Insert Field***

With this powerful feature in some versions of VisualRadio you can add user defined fields to all channeltables.



**The settings will only be written to the table if the device is a 'Channel Data Source' as defined per 'Devices -> Configure'**

**Insert New Field**

Name:

Text  
  Yes/No  
  Single  
 Double  
 Integer  
 Date/Time

|            |      |
|------------|------|
| ACF        | Text |
| AGC        | Text |
| Attenuator | Text |
| BAUDRATE   | Text |
| Bearing    | Text |
| BFD        | Text |
| BLANKER    | Text |
| BLOB       | Memo |
| CALLSIGN   | Text |
| CENTER     | Text |

Buttons: Add, Close

Enter the name of the new field in the text box 'Name' and select the type of field from the options listed under 'Type'. The size of text fields is set automatically at 255 characters. After making your entries press the button 'Add'.

Note that field names cannot be given twice and that the space bar cannot be used in field names. The list contains the names of the fields in the active table.

The new field is entered in the database and in the display of the table on your computer monitor.

## Extras

### ***Mixer***

Launches the Windows audio mixer

### ***Set GPS Time***

Sets the system time to the time of the GPS device, if such a device is available

### ***Select GPS Source***

Selects between manual input of GPS data or use of GPS Receiver.

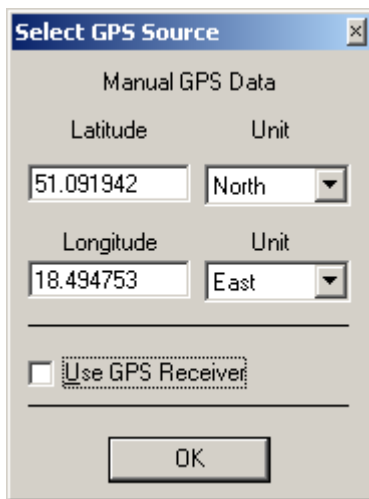

### ***Decoder***

This feature is only available with certain versions and will store the status of the WAVECOM W41PC/W51PC decoder into the current Channeltable along with the main-receiver's parameters.

### ***VisualRadio Basic***

This feature is only available with certain versions and will bring up VisualRadio Basic Language.

### ***Load and Go...***

Loads a VisualRadio Basic Script and starts it immediately.

## Chat

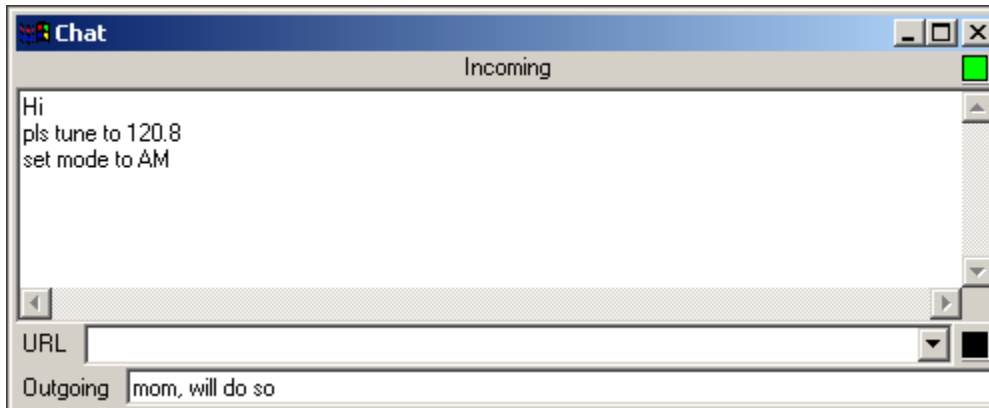

The optional Chat feature provides interconnection of all stations in a VisualRadio network to exchange messages. The upper led signals incoming connections and the lower outgoing connections.

To initiate a connection type the URL into the field 'URL' and hit ENTER

## Crypt Options...

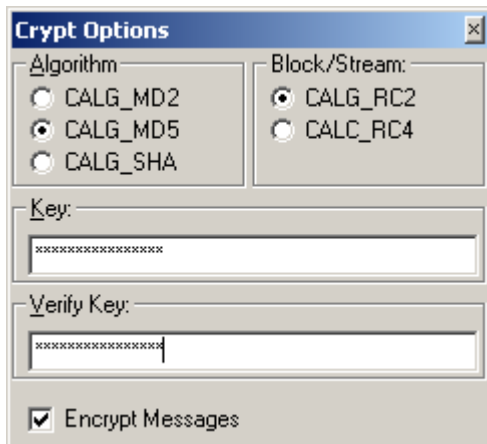

This optional feature encrypts the chat and may also be used by VisualRadio Basic. The user may choose between 3 algorithms and the use of block cypher or stream cypher.^

## Options...

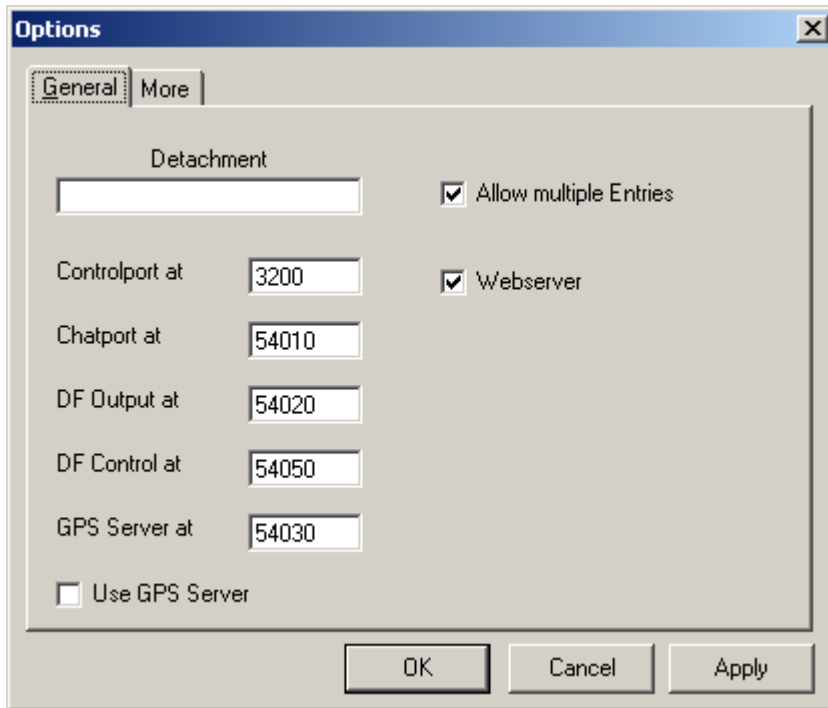

|                       |  |
|-----------------------|--|
| <b>Detachment</b>     | This string is used in the field 'DET' of Channeltables                            |
| <b>Controlport at</b> | Specifies port for TCP/IP control of VisualRadio                                   |
| <b>Chatport at</b>    | Specifies chatport, optional   |
| <b>DF's Port at</b>   | Specifies port for additional information, if a Direction Finder is used, optional |
| <b>GPS Server at</b>  | Port for the optional GPS Server, which also allows for up to 20 clients           |
| <b>Use GPS Server</b> | Check to activate the communication between VisualRadio and the GPS Server         |

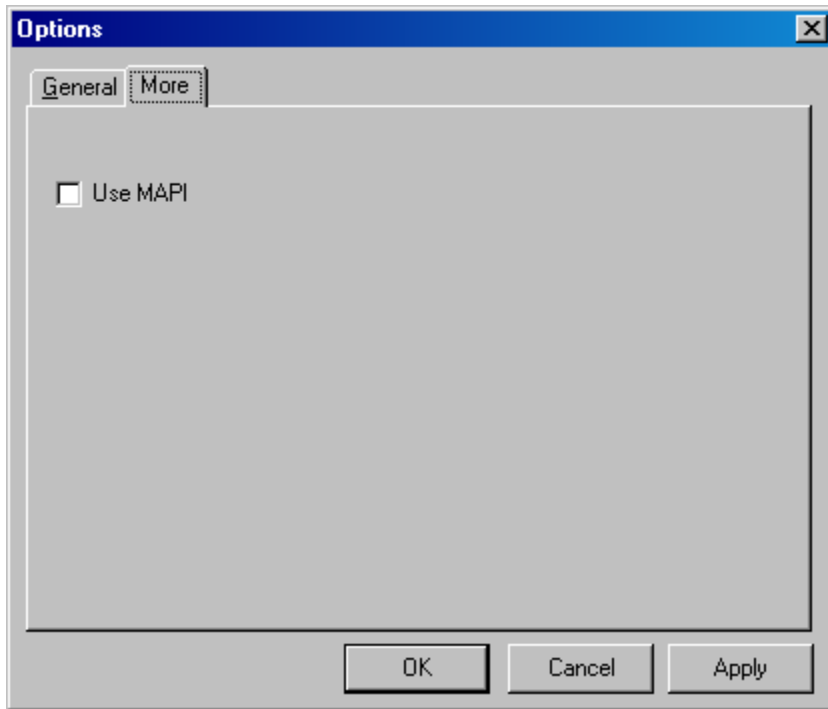

**USEMAPI**      Determines wether MAPI may be used with VisualRadio Basic

## Functions specific to Direction Finders

VisualRadio FALCON provides the following functions, specific to Direction Finders:

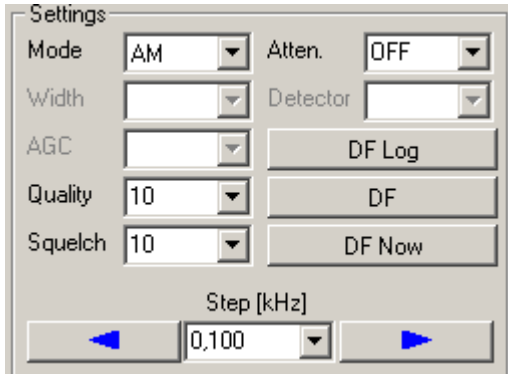

- **DF Log** Logs DF's data, as defined per 'Quality' and 'Squelch' to its current Channelvaluetable until pressed again
- **DF** Waits for one signal and saves the DF'S values to the Valuetable
- **DF Now** Does a manual DF, regardless of 'Quality' and 'Squelch'

## Output of Direction Finders Data to other Applications

An entry of a Direction Finder's data into one of the Channelscanvalues tables may be manually exported to other applications by a doubleclick in field 'Signal' of the corresponding table

| Frequency  | Signal | Date       | Time     | Acq. End [Date] | Acq. End [Time] | GPS     | Unit | GPS    | Unit | Height | Unit | Sats | Bearing | Quality | Origin  | DET      | ID |
|------------|--------|------------|----------|-----------------|-----------------|---------|------|--------|------|--------|------|------|---------|---------|---------|----------|----|
| 120,800000 | 18     | 09.07.2003 | 13:28:29 | 09.07.2003      | 13:28:32        | 50.0919 | N    | 8.4947 | E    | 124    | M    | 4    | 58      | 11      | DF-4400 | Unit Red | 51 |
| 120,800000 | 42     | 09.07.2003 | 13:28:23 | 09.07.2003      | 13:28:24        | 50.0919 | N    | 8.4947 | E    | 123    | M    | 4    | 222     | 6       | DF-4400 | Unit Red | 51 |

Format of the exported line, please note the delimiters

- 'ROW:'
- [Line of valuetable]:
- [Name of Valuetable]:
- [Detachment as per 'Options'],

Exported fields:

- Frequency,
- Signal Level,
- Date,
- Time,
- End of Acquisition [Date],

- End of Acquisition [Time],
- GPS,
- Unit of GPS [North/South],
- GPS,
- Unit of GPS [East/West],
- Height,
- Unit of Height,
- Number of Satellites,
- Audiofile,
- Tracefile (currently not used),
- Bearing,
- Quality,
- Origin of SOI, i.e. receivers tag,
- Audiokey (currently not used)
- Detachment,
- ID of corresponding row in the DF's attached Channeltable

The string is delimited by an ASCII Carriage Return/Linefeed

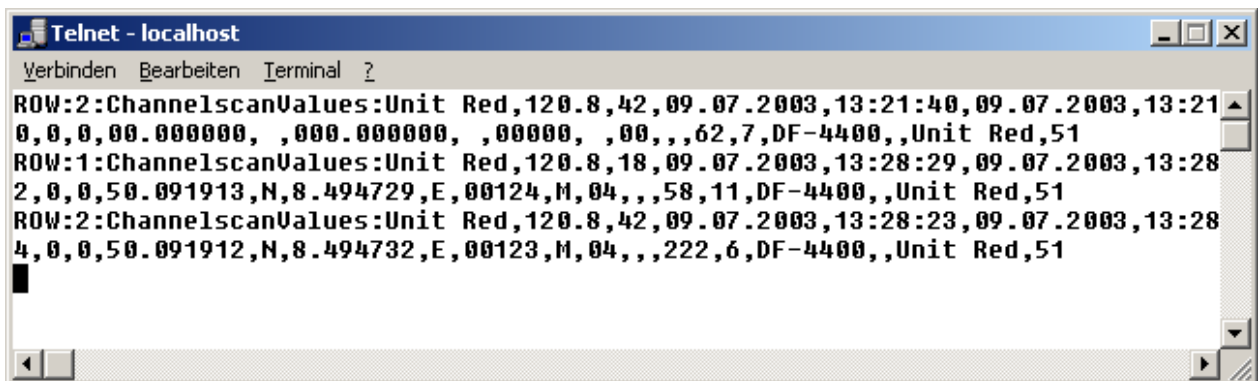

```

Telnet - localhost
Verbinden Bearbeiten Terminal ?
ROW:2:ChannelscanValues:Unit Red,120.8,42,09.07.2003,13:21:40,09.07.2003,13:21
0,0,0,00.000000, ,000.000000, ,00000, ,00,, ,62,7,DF-4400,,Unit Red,51
ROW:1:ChannelscanValues:Unit Red,120.8,18,09.07.2003,13:28:29,09.07.2003,13:28
2,0,0,50.091913,N,8.494729,E,00124,M,04,, ,58,11,DF-4400,,Unit Red,51
ROW:2:ChannelscanValues:Unit Red,120.8,42,09.07.2003,13:28:23,09.07.2003,13:28
4,0,0,50.091912,N,8.494732,E,00123,M,04,, ,222,6,DF-4400,,Unit Red,51

```

Result of connecting a Telnet terminal to the DF's port



As with all Valuetables, the user may do a right mouseclick on the row of interest to export the row to a comma-delimited entry in the corresponding Channelreport File, e.g. DF4400\_Channelreports. Note that the reportfiles name is prefixed by the devices tag

## The GPS Server – Optional

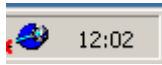

The GPS Server is automatically launched by VisualRadio and places itself in the Taskbar. It allows simultaneous connections of up to 20 clients. We recommend its use due to the streaming nature of the GPS data and because various other programs, like mapping software, may use its data at the same time.

The operation of the server is completely transparent to the user. The servers communication parameters must be set with 'Devices -> Configure...'

A right mouseclick on its icon in the Taskbar reveals the following functions:

### ***Always on Top***

Toggles state of the GPS Servers window, if visible

### ***Stop Server/Start Server***

Stops Server temporarily or starts it again

### ***Show Server/Hide Server***

Toggles visibility of the server

### ***Enable Remote Shutdown***

If checked, will be automatically shut down at the end of a VisualRadio session

### ***Send Buffer***

If checked, it will send its complete buffer to all connected applications. If not checked, it will send only the line starting with \$GPGGA



GPS Server in 'Line Mode'



**In the case of not sending its buffer, i.e. 'Line Mode', the string is extended to contain the machines and the operator's name**

**VisualRadio GPS Server-Copyright 2003 Liedtke GmbH**

```

A,5009.1874,N,00849.4653,E,0.0,20.1,090703,0.4,E,A*26
$GPRMB,A,,,,,,,,,A,A*0B
$GPGGA,102928,5009.1874,N,00849.4653,E,1,03,4.7,132.8,M,47.8,M,,*46
$GPGSA,A,2,01,,,,,11,13,,,,,4.8,4.7,1.0*3E
$GPGSV,3,1,11,01,61,191,44,04,29,307,00,05,00,346,00,07,33,264,00*7C
$GPGSV,3,2,11,11,31,149,38,13,30,212,41,20,76,060,00,25,27,058,00*72
$GPGSV,3,3,11,30,00,010,00,33,28,211,38,44,13,118,00*42
$GPGLL,5009.1874,N,00849.4653,E,102928,A,A*40
$GPBOD,,T,,M,,*47
$PGRME,25.6,M,14.2,M,29.3,M*10
$PGRMZ,436,f,2*1B
$PGRMM,WGS 84*06
$GPRTE,1,1,c,*37
-----

```

GPS Server in 'Buffer Mode'

### ***Close Menu***

Closes the popup menu

### ***Unload Server***

Manually unloads Server and immediately disconnects all clients

### ***About VisualRadio GPS Server***

Information about version etc. of the GPS Server

## Scanning Sectors (Searching)

This function scans the band between two selected frequencies with a user supplied stepsize. To make the Scan Panel visible press the 'Scanner' button in the Control Panel.



If the Recorder Panel, HF-Spectrum Panel or the TCP/IP Panel was previously displayed it will be replaced by the Scanner Panel

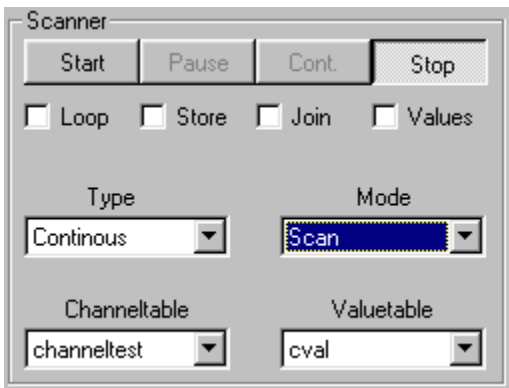

The Scan Panel provides the following items:

### Scan Functions

- 'Start' - Starts searching
- 'Pause' - Pauses a search
- 'Cont.' - Continues a paused search
- 'Stop' - Stops a search

### Scan Modifiers

- 'Loop' - Loops through a table indefinitely
- 'Store' - Stores parameters of found frequencies to the current channeltable in Mode 'Search'
- 'Join' - Turns display of the search-spectrum in non-histogram mode on or off
- 'Values' - Stores parameters to the current channel- or sectorvaluetable

**Scan Types**

- 'Continuous' - Scans continuously
- 'Halt' - Pauses when the signal level is reached and waits until the signal falls below this level
- 'Pause' - Stops when the signal level is reached and waits for the specified time ( Dwelltime )
- 'Stop' - Stops scan when signal level is reached

**Scan Modes**

- 'Scan' - Tunes all frequencies of the current Channeltable
- 'Search' - Tunes all frequencies in a sector of the current Sektortable with specified stepsizes

**Scantable Indicator**

- In mode 'Scan' the name of the current receivers Channeltable is displayed. The label above the box displays 'Channeltable'
- In mode 'Search' the name of the current receivers Sektortable is displayed. The label above the box changes to 'Sektortable'

You might select another table from the box

**Valuetable Indicator**

- In mode 'Scan' and 'Search' the current Valuetables are displayed
- In mode 'Scan' the current Channeltable is displayed. Also the label above the box displays 'Channeltable'

You might select another table from the the box

**Sessiontable Indicator**

- For DF-devices the current Sessiontable is displayed

You might select another table from the the box

**Example: Scan Sectors (Search)**

To search a certain range first press the 'Scanner' button in the Control Panel. Check the following fields using the benchmark frequencies in the scan table:

1. Start- and end frequencies
2. Step – Interval
3. Dwelltime - Dwell time at signal
4. Signal - Minimum signal strength in 'Pause' and 'Halt' modes
5. Click the left margin of the row containing the frequency range of your choice - the row is highlighted in white on blue
6. Select 'Pause' or 'Halt' in the scan bar and press the 'Start' button

To improve resolution choose as small a frequency range as possible in the 'Width' box on the control bar.

A double-click of the mouse on the graphic display tunes the receiver to the station.

### Important !

**Recording is only possible if a soundcard is installed and you have a cable between radio-AF and soundcard and the field 'Active' is activated in the Channelscan Table!**

## Recorder

To make the Recorder visible press the 'Recorder' button in the Control Panel. If the Scanner Panel, HF-Spectrum Panel or the TCP/IP Panel was previously displayed it will be replaced by the Recorder

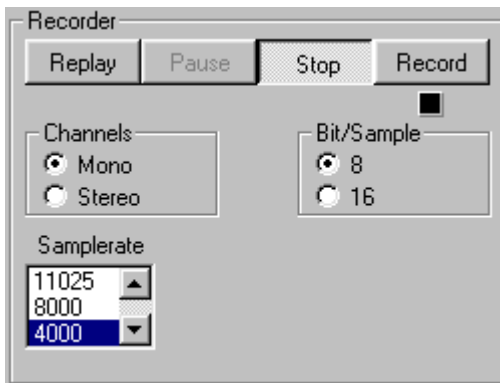

This menu is used to record broadcasts and to play recorded broadcasts when a soundcard is installed.

Parameters with choice of sampling rates, channel settings and bits per sample. Required memory space on your haddisk can be calculated using the following formula:

channels X bytes per sample per channel X sampling rate

### Example

For 16 bit stereo at 44,1 kHz:

$2 \text{ (channels)} * 2 \text{ (Bytes per sample per channel)} * 44100 = 176400 \text{ Bytes per second}$

But for 8 bit mono at 4000 Hz the required capacity is only:

$1 \text{ (channel)} * 1 \text{ (bytes per sample per channel)} * 4000 = 4000 \text{ bytes per second}$

The control buttons

- 'Replay' - Allows for selection of a previously recorded audio file and replays it
- 'Pause' - Momentarily pauses a playing audio file
- 'Stop' - Stops playing or recording
- 'Record' - Records a transmission

Automatically recorded broadcasts - such as those made during a Channelscan when the 'Record' field is enabled - are saved in the directory '..\VRADIO32\DATENAUDIO' with the file names:

*ddmmyy\_hhmmss\_fffffffff.WAV*

e.g. 121003\_131050\_0006075000 means that the broadcast was recorded on

12th October 2003 at 13:10:50 on frequency 6.075000



Some versions may provide a different recorder

## Frequency Display and Receiver Settings

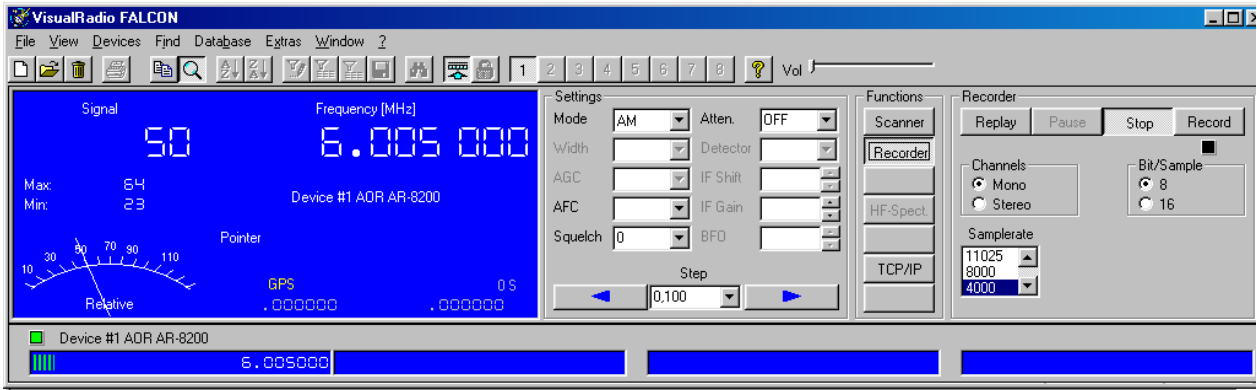

Displays various parameters of the tuned station.



**The arrows at both sides of the 'Step' box tune the frequency up or down. If pressed for more than 1 second they will continuously tune the frequency. You can enter up to 30 different tuning steps, use "Del" to delete an entry**

To enter a frequency, click on the frequency display and enter the frequency in MHz.

Access to the receiver settings:

|              |   |
|--------------|---|
| <b>Mode</b>  | Demodulation type   |
| <b>Width</b> | IF Bandwidth  |
| <b>Agc</b>   | Automatic Gain Control  |
| <b>Notch</b> | Notch frequency, Cubic LCR Series: selection of AGC Attack Time   |
| <b>Blk</b>   | Noise blanker level, Cubic LCR Series: selection of AGC Decay Time  |
| <b>Sql</b>   | Squelch level   |
| <b>Pbt</b>   | Passband tuning   |
| <b>Bfo</b>   | BFO   |
| <b>Step</b>  | Selects a tuning step, you can enter up to 30 tuning steps, use 'Del' to delete a step. The arrows tune up and down, if pressed for more than 1 second they tune continuously |



**The contents of the 'Settings' panel may change by selecting a different receiver as the main receiver**

The signal display is composed of the following elements

|                                       |   |
|---------------------------------------|---|
| <b>Min/Max -</b>                      | Holds the corresponding signal levels                     |
| <b>dBm, dB[mV],</b>                   | Display of signal level, as per 'Devices -> Signal Units' |
| <b>dB[<math>\mu</math>V], mV RMS,</b> |   |
| <b>mV Peak-to-Peak,</b>               |   |
| <b>Amateur S-Units</b>                |   |
| <b>Analogdisplay</b>                  | Displays the signal in dB                                 |

## Write Channelscan Values

Activate the box 'Values' in the scan panel - incoming receiver field strengths are automatically transferred to the Channelscan Value file that is in use. If necessary, open the Channelscan Value file.

## Write Sectorscan Values

Activate the box 'Values' in the scan panel - incoming receiver field strengths are automatically transferred to the Sectorscan Value file that is in use. If necessary, open the Scan Value file.

## Examples

### *Examples: Scan Channels*

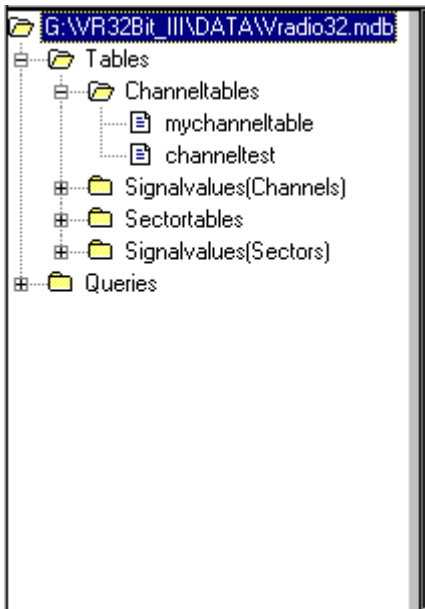

1. Select 'Database -> Open' or press the 'F4' key
2. Check the following fields in the channel table containing the channels that are to be scanned:  
Frequency, AGC, Width, Mode
3. Also check the fields  
Signal - Minimum signal strength in 'Pause' and 'Halt' modes  
Dwelltime - Time to stay on frequency when a signal is found  
Active - Determines whether a channel is included in a scan
4. Select 'Pause' or 'Halt' from the 'Type' box and press the 'Start' button.

Double-clicking the mouse on the graphic display tunes the receiver to the corresponding frequency.

### **Example: Write Frequencies Found to a Table**

To search a frequency range and automatically enter the frequencies found in the current Channelscan Table:

- Create a new Channel Scan Table and activate the table by pressing 'File Open Channeltable' or activate an existing table
- Open the Sector Scan Table of your choice
- Mark the range you wish to scan - it is highlighted in white on blue
- Enter appropriate values for 'Dwelltime' and 'Signal' in the Sector Scan Table, e.g. 'Dwelltime 1' and 'Signal 100' (i.e. wait 1 second at a minimum signal strength of -100 dBm)
- Activate the box 'Store' in the Scan Panel
- Select the scan mode 'PAUSE', the program will pause for one second
- Press the 'Start' button on the Scan Panel

### *Edit Mode of Tables*

|   | ID | Hits | Date       | Time     | Frequency | Station        | Country |
|---|----|------|------------|----------|-----------|----------------|---------|
| ▶ | 39 |      | 09.07.2003 | 11:46:59 | 6,075000  | Deutsche Welle |         |
| * |    |      |            |          |           |                |         |

As long as the tables are in Edit Mode, the edited fields background turns red and the windows title flashes. To exit Edit Mode click on a row below or above the edited row.



**Valuetables cannot be edited, only complete rows may be deleted**

## TCP/IP: Overview

VisualRadio Server offers support for the TCP/IP – protocol to control receivers and transceivers over LAN/WAN or the Internet.

You can tune the linked devices either by a browser, which supports Java, or by a user specific software. The set of commands is documented at the end of this document.

The audio transport can be done by any appropriate audio producer/server. You will find the description of the usage of Windows Media in a later chapter. You can also use the RealNetworks server/producer for this purpose.

VisualRadio FALCON can be used for the setup of a radio network. The extension of this network can reach from the connection of just two stations to a worldwide network over the World Wide Web.

## Hint

Please make sure that you use the software according to the laws in your country concerning the allowed frequencies. Not all countries allow the listening to and transmission of all radio traffic.

To adapt VisualRadio to this limitation, you have the option ‚Bandplan‘ in the menu ‚Extras -> Options -> General‘. If the bandplan is activated, VisualRadio only provides the following frequencies for external tuning by the TCP/IP – protocol

If you operate VisualRadio directly from your host, the bandplan will be ignored.

## Step By Step

In the following you will find a description of the necessary steps to setup a remote IP link.

### *The Receiver*

#### **Scenario A: 1 Computer In A Local Network**

Please make sure, that Windows Network is installed on your computer. You may find the icon on your desktop. If it is not installed, install it from the Windows CD first.

Check as well whether a web browser is installed. If necessary, install the browser first. We recommend Microsoft Internet Explorer 5 and above due to its support for ActiveX.

### **Configuration Of The Network Under WINDOWS**

Click with right mouse button on ,Network Neighborhood' und select ,Properties' and mark the network adapter in the appropriate folder.

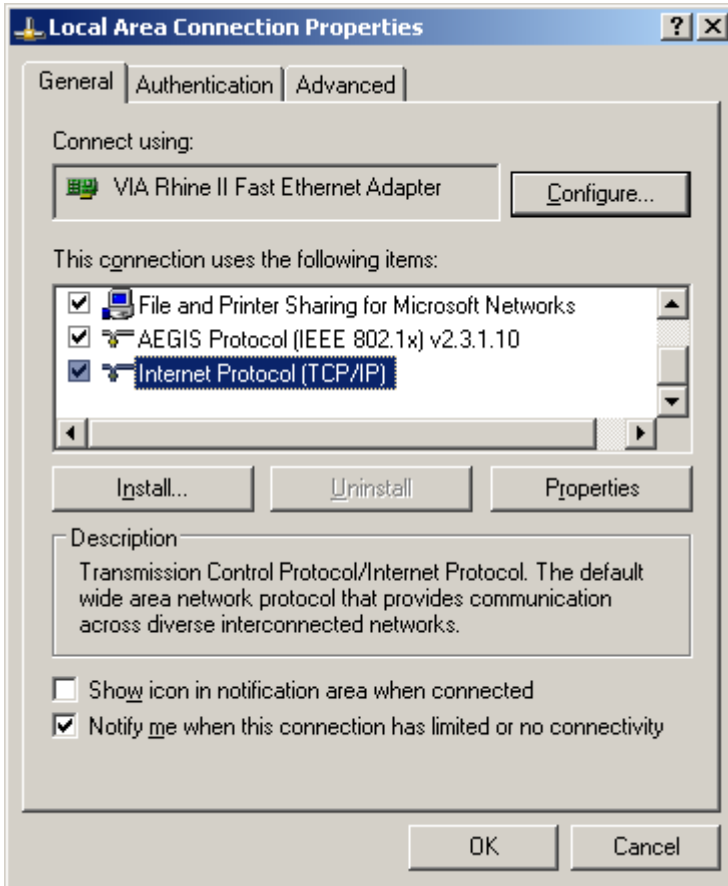

Click on ,Properties' again und select ,IP address ". Enter a valid IP address

Close the dialog box with ,OK'. WINDOWS will prompt you for the CD. After the installation reboot the computer.

### **Configuration Of The Network Under WINDOWS NT/2000/XP**

Click with the right mouse button on ,Network Neighborhood ', select ,Properties ' then ,Protocols '

Select the TCP/IP protocol and click on ,Properties '

Enter an IP address for the network adapter.  
**Your computer now has an IP address in your local network, even if you have a stand alone computer.**

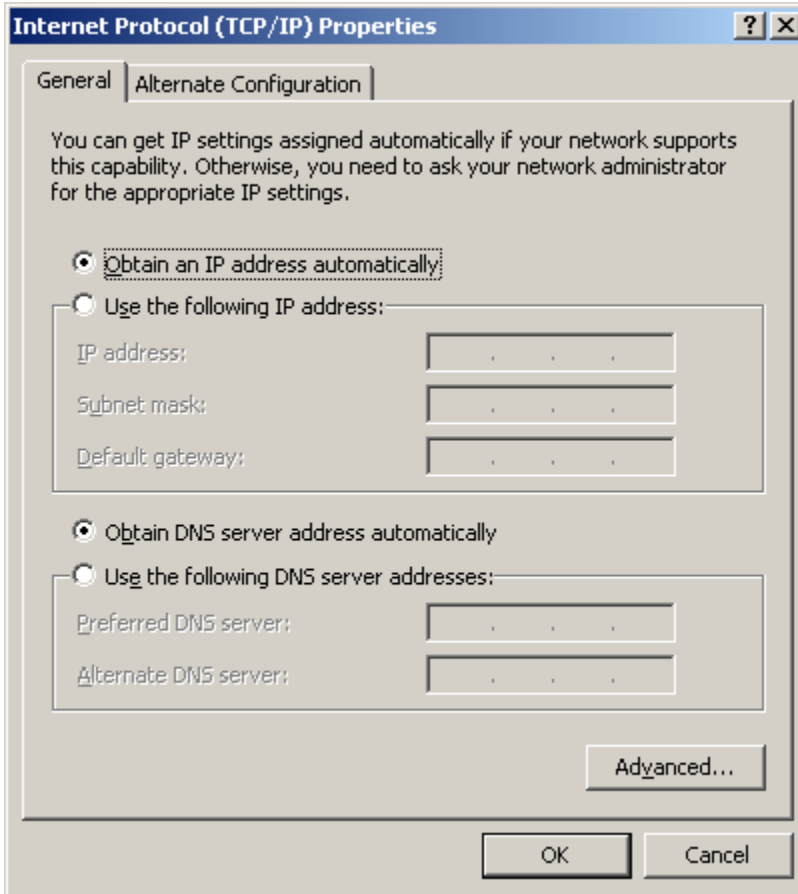

### ***Linking Devices To WAN/ LAN / Internet***

Start the VisualRadio server. You will see the enhanced frequency display and the display of the linked IP-Port.

Now make a connection between VisualRadio and the receiver/tranceiver.

Start TELNET.EXE. Select ,Connect' ,Remote System" from the menu. and Port 3200 which may be altered from menu 'Options'.

Click on the button ,Connect'. If the link is made, you will see on the Telnet screen information like this:

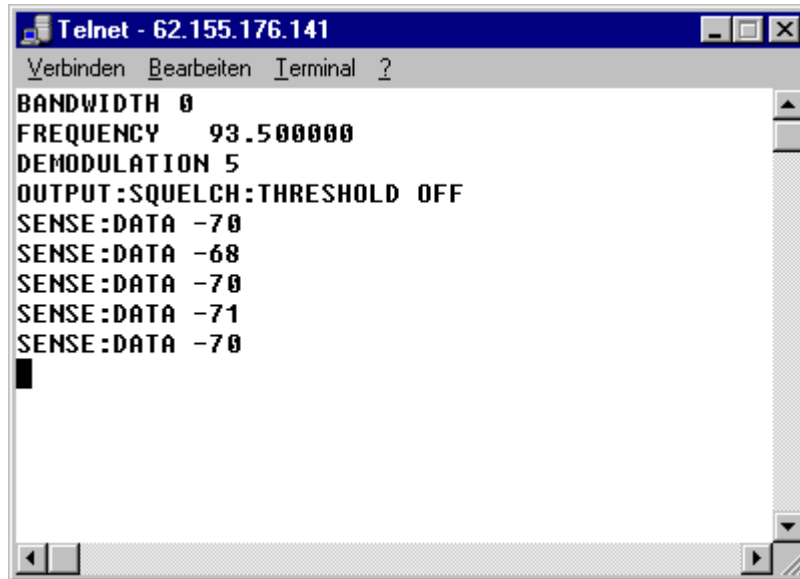

Here you see that VisualRadio Server has sent relevant parameters to the client (Telnet), when the link has been established. These parameters are the bandwidth, frequency and so on. After this initialization, the signal level is continuously transmitted.

Disable 'Options -> Extras -> Webserver' to interrupt the transmission of the signal level temporarily. Activate the option 'Local Echo' in TELNET under 'Terminal -> Preferences' and close the window with OK.

Enter the string

\*IDN?

in the TELNET screen and confirm with 'Enter'. VisualRadio will then transmit the type of the connected receiver.

```

Telnet - 62.155.176.141
Verbinden Bearbeiten Terminal ?
BANDWIDTH 0
FREQUENCY 93.500000
DEMODULATION 5
OUTPUT:SQUELCH:THRESHOLD OFF
SENSE:DATA -70
SENSE:DATA -68
SENSE:DATA -70
SENSE:DATA -71

*IDN?
IC-R8500

frequency 6.075
FREQUENCY 6.075000
BANDWIDTH 1
DEMODULATION 4
DEMODULATION 2

```

Enter finally a frequency, for example

frequency 6.075

und confirm it with ‚Enter‘.

VisualRadio will correct the bandwidth and the modulation in collaboration with the linked device, if necessary. Set these parameters afterwards according to your needs. On the right side of the display your own computers IP address appears as client.

### **Scenario B: More Than One Computer In The Local Network**

Proceed like in ‚Scenario A‘, but start the program TELNET.EXE from another computer and connect from this to the VisualRadio server.

By doing this, you make sure the full functionality of your VisualRadio server. You can then start with the installation of the audio software.

### ***The Audio Part***

The precondition for the transmission over the internet is an appropriate web server, for example the Microsoft Personal Web Server or the Internet Information Server.

Check the existence of the respective server on your computer und install it, if necessary.

### **Microsoft Media**

If it is not on your system, download a player from Microsoft.

#### **IMPORTANT !**

Install the player and test its functionality.

On the same page you may find under

#### **Windows Media Tools and Services**

VisualRadio FALCON 7

the **Windows Media Tools** and  
the **Windows Media Tools**

Also install one of these packages. Afterwards you will find the Windows Media Windows program group with Media Encoder icon.

Check the connection between the receiver and the sound card and start the production.

### **IMPORTANT !**

You must select a port for producing audio. This port will be used later by the server.

## ***How to Bring Your Receiver to WAN/LAN and Internet***

Insert a hyperlink to the page TUNE.HTML which is included in the VisualRadio package, into your home page

Start the VisualRadio server version 7 and then the Audio Encoder

Copy the files TUNER.CLASS, SEVENSEGMENTPANEL.CLASS, TUNE.HTM and TUNE.H2.GIF in the root directory of your web server. In most cases it is ..\INETPUB\WWWROOT

Now you have to correct the IP address on the page TUNE.HTML To do this, go online

Remember the IP address of the PPP adapter.

### **How to deploy the dynamic IP**

If you have an HTML editor, for example Microsoft Frontpage Express, you can use this for changing the page, otherwise use your web browser.

Search for the string

192.168.0.8

Change all the addresses 192.168.0.8 to the current address, which you found out by using the programs mentioned above. There are four changes to do this.

For the first two replacements you have to select a port for the Encoder. In the example it is port 1097.

name="FileName" value="http://192.168.0.8:1097">

filename=<http://192.168.0.8:1097>

codebase=<http://192.168.0.8/>

host="192.168.0.8">

Save the page.

### **How to deploy the other parameters**

You can also put the 3 parameters MODE, WIDTH and SQUELCH on to the page:

### **MODE**

Search for the line

<param name="mode0" value="Mode|DEMODULATION|... >

<param name="mode0" value="Mode|DEMODULATION|LSB|USB|AM|CW|FM|FMW">

Replace the modes i.e. ,LSB', ,USB...' by the demodulation type of your device in the box ,Mode' of the VisualRadio display. Open the appropriate listbox in VisualRadio and copy all items, which are valid for your device.

**WIDTH**

Search for the line

```
<param name =mode2 value=Width|BANDWIDTH...>
```

```
<param name="mode2" value="Width|BANDWIDTH|WIDE|NORMAL|NARROW">
```

Replace all the modes in the example i.e ,WIDE,NORMAL,NARROW“ by the bandwidth of your receiver in the box ,Width‘ of the VisualRadio display. To do this, open the listbox and copy all valid values into the page.

**SQUELCH**

Search for the line

```
<param name=mode3 value=Sql.|#V#OUTPUT:SQUELCH_THRESHOLD...>
```

```
<param name="mode3"
```

```
value="Sql.|#V#OUTPUT:SQUELCH:THRESHOLD|0|10|20|30|40|50|60|70|80|90|100|110|120|130|140|150|160|170|180|190|200|210|220|230|240|250">
```

Replace the modes in the example, i.e ,0,10,20...‘ by the squelch values for your receiver in the box ,Sql‘ of the VisualRadio display. To do this, open the listbox and copy the valid values

Save the page again und test it with a web browser.

The browser will connect to VisualRadio and to the audio server.

## The TCP/IP Command Set

Note: These may not all be implemented

|                               |   |   |
|-------------------------------|---|---|
| "SENSE:DATA?"                 | Sends signal level in dBm   |   |
| "*IDN?"                       | Sends the receiver type   |   |
| "FREQUENCY?"                  | Sends the frequency   |   |
| "FREQUENCY "                  | Sets the frequency<br>example:.FREQUENCY 6.075                      |   |
| "GCONTROL:MODE?"              | Sends AGC   | * |
| "AGC "                        | Sets AGC  | * |
| "INPUT:ATTENUATION:STATE?"    | Sends attenuator  | * |
| "INPUT:ATTENUATION: "         | Sets attenuator   | * |
| "OUTPUT:SQUELCH?"             | Sends squelch as LISTINDEX,<br>VALUE – example:. 0,OFF              | * |
| "OUTPUT:SQUELCH:THRESHOLD "   | Sets squelch - example:<br>OUTPUT:SQUELCH:THRESHOLD 50              | * |
| "DEMODULATION?"               | Sends demodulation type as<br>LISTINDEX, VALUE – example:.<br>5,FMW |   |
| "DEMODULATION "               | Sets demodulation – example:<br>DEMODULATION 3                      |   |
| "BANDWIDTH?"                  | Sends the bandwidth as LISTINDEX,<br>VALUE – example: 0,WIDE        |   |
| "BANDWIDTH "                  | Sets the bandwidth – example:<br>BANDWIDTH 2                        |   |
| "SYSTEM:AUDIO:VOLUME?"        | Sends the volume  | * |
| "SYSTEM:AUDIO:VOLUME "        | Sets the volume   | * |
| "DETECTOR:FUNCTION?"          | Sends the detector  | * |
| "DETECTOR:FUNCTION "          | Sets the detector   | * |
| "SYSTEM:RECEIVER:SELECT "     | Selects the current receiver  |   |
| "SYSTEM:RECEIVER:SELECT?"     | Sends the selected receiver   |   |
| "SYSTEM:SCANNER:CHANNEL?"     | Sends the current channel from the<br>active table                  | * |
| "SYSTEM:SCANNER:CHANNEL "     | Sets current channel of the active<br>Channeltable                  | * |
| "SYSTEM:SCANNER:SECTOR?"      | Sends current sector of the active F1-<br>>F2 Table                 | * |
| "SYSTEM:SCANNER:SECTOR "      | Sets current sector of the active F1-<br>>F2 Table                  | * |
| "SYSTEM:CHANNELSCANNER:START" | Starts scanning the current Chan-<br>neltable                       | * |
| "SYSTEM:CHANNELSCANNER:STOP"  | Stops scanning the current Chan-<br>neltable                        | * |

|                                  |  |   |
|----------------------------------|--|---|
| "SYSTEM:CHANNELSCANNER:PAUSE"    | Pauses Channelscan   | * |
| "SYSTEM:CHANNELSCANNER:CONTINUE" | Continues paused Channelscan   | * |
| "SYSTEM:SECTORSCANNER:START"     | Starts F1 -> F2 Scan   | * |
| "SYSTEM:SECTORSCANNER:STOP"      | Stops F1 -> F2 Scan  | * |
| "SYSTEM:SCANNER:PAUSE"           | Pauses F1 -> F2 Scan   | * |
| "SYSTEM:SCANNER:CONTINUE"        | Continues paused F1 -> F2 Scan   | * |
| "SYSTEM:SCANNER:TYPE "           | Sets Scantype, i.e. 0=CONT, 1=HALT, 2=PAUSE, 3 = STOP                          | * |
| "SYSTEM:SCANNER:TYPE?"           | Sends current scantype   | * |
| "SYSTEM:SCANNER:HALTED TRUE"     | Sent when the scanner ist halted, paused or stopped                            | * |
| "SYSTEM:SCANNER:HALTED FALSE"    | Sent when scanner is scanning  | * |
| "SYSTEM:SCANNER:STATUS "         | Sent when scanner is started (=1), paused (=2), continued (=3) or stopped (=4) | * |
| "SYSTEM:BANDSCOPE "              | Toggles Bandscope ("ON / OFF")   | * |
| "SYSTEM:BANDSCOPE?"              | Sends current state of bandscope   | * |
| "SYSTEM:USER:CHAT "              | Send chatdata to the server for broadcasting                                   | * |
| "SYSTEM:USER:LOGIN "             | Logs in to the radio server. Format "Parameter1   Parameter2"                  | * |
| "SYSTEM:USER:LOGOFF "            | Notifies the server. Format "Parameter1   Parameter2"                          | * |
| "SYSTEM:USER:CONNECTED "         | Servermessage to notify clients of all connected clients                       | * |
| "SYSTEM:USER:OPC"                | Notifies clients of 'Operation Complete'                                       | * |

\* = Not provided with all versions

# HF-Spectrum

For spectra devices the HF-Panel is available

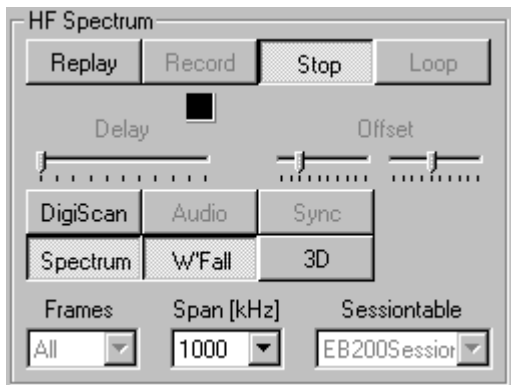
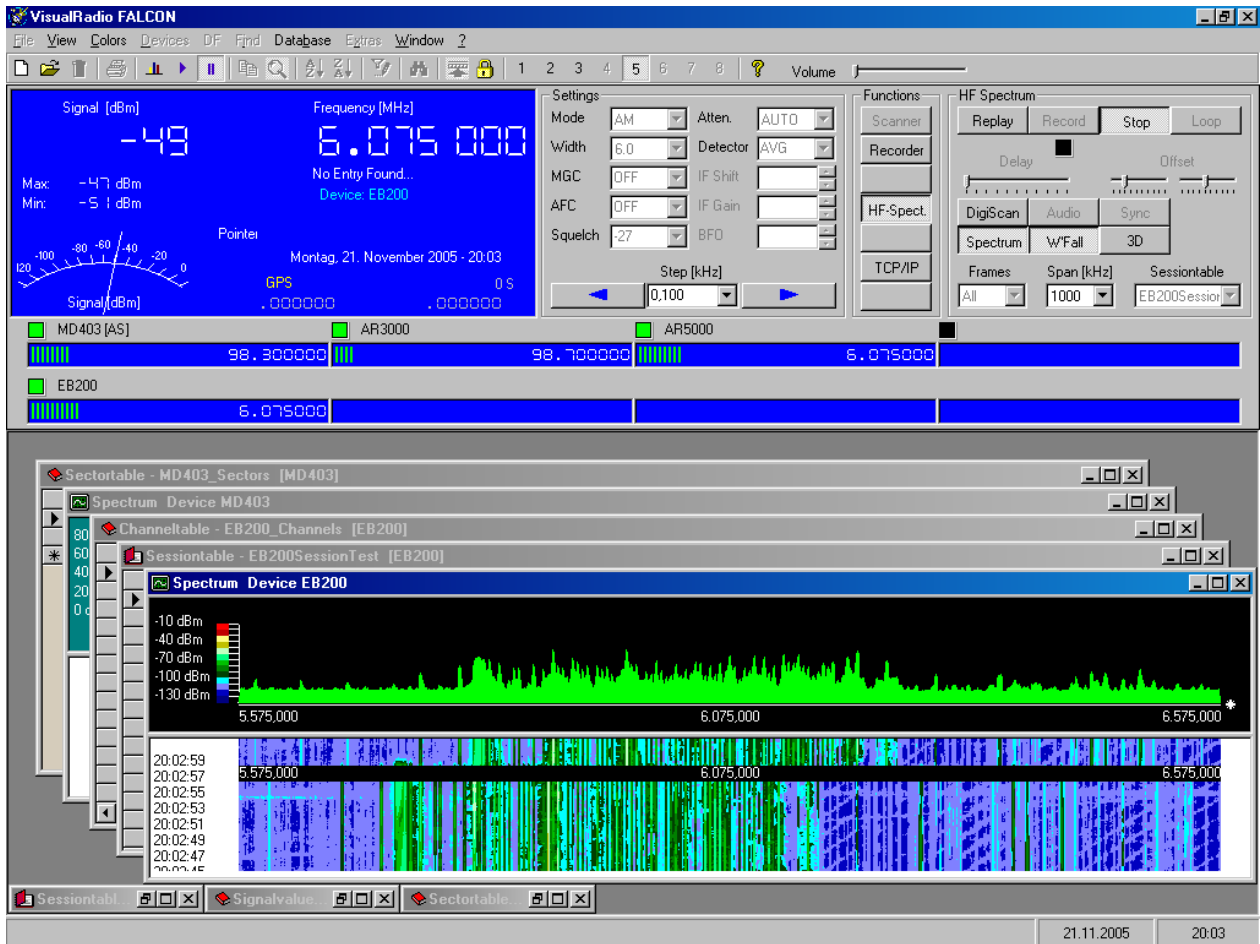

- The sectortable now contain additional columns for "Mode", "Filter\_A", "Filter\_B" and "Span"
- During 'DigiScan' funktionen 'Loop', 'Store' and 'Values' in Panel 'Scanner' are valid
- Spectrumdisplay: if a device is capable of delivering spectra the button 'HF-spectrum' is available

## Description of Buttons

|                                  |   |
|----------------------------------|---|
| Button <b>Spectrum</b> pressed   | Locks functions/menus'File', 'Devices', 'Extras', 'Frames', 'Sessionables', 'Scanner', and all controlfunktionen in Panel 'Settings', unlocks 'DigiScan', 'Wfall', and '3D' and displays the spectrum |
| Button <b>Spectrum</b> unpressed | Unlocks functions/menus'File', 'Devices', 'Extras', 'Frames', 'Sessionables', 'Scanner', and all controlfunktionen in Panel 'Settings', locks 'DigiScan', 'Wfall', and '3D'                           |
| Button <b>WFall</b> pressed      | Displays a waterfall of signal levels with corresponding times attached   |
| Button <b>WFall</b> unpressed    | Swichtes waterfall off  |
| Button <b>DigiScan</b> pressed   | Unlocks button 'Record' and starts the DigiScan, which is based on the devices current sectortable  |
| Button <b>DigiScan</b> unpressed | Locks button 'Record' und stops DigiScan  |
| Button <b>Audio</b> pressed      | If pressed records audio of maximal signal during DigiScan for the 'Dwelltime', defined in the corresponding sectortable  |
| Button <b>Audio</b> unpressed    | Does not record audio   |
| Button <b>3D</b> pressed         | Enables sliders'Offset' and displays the spectrum 3-dimensional graphically   |
| Button <b>3D</b> unpressed       | Disables sliders 'Offset' and displays the spectrum 2-dimensional   |
| Button <b>Sync</b> pressed       | Synchronizes audio- and spektraldata during replay  |
| Button <b>Sync</b> unpressed     | Disables synchronisation of audio- and spektraldata   |
| Slider <b>Delay</b>              | Insert an adjustable delay during replay  |
| Slider <b>Offset</b>             | Left slider inserts in 3D y-Offset, right slider x-Offset ein   |
| Button <b>Record</b> pressed     | Startsrecording of spectral- and, if 'Audio' button is pressed, also audiodata  |
| Button <b>Record</b> unpressed   | Stops recording   |
| Button <b>Replay</b> pressed     | Starts replay of spectra- and, if button 'Audio' is pressed, also audiodata. The parameters come from the devices current sessionable   |
| Button <b>Replay</b> unpressed   | Stops replay  |

### Description of other controls

|                           |  |
|---------------------------|--|
| Combo <b>Frames</b>       | Specifies number of frames to display during replay,i.e 'All', each 2 <sup>nd</sup> etc.               |
| Combo <b>Span</b>         | For EB200 displays current span, also gives the user the possibiltiy to set a 'Span'                   |
| Combo <b>Sessiontable</b> | Displays devices current sessiontable, also gives the user the possibiltiy to set a a new sessiontable |

- For All graphic displays colors for background, foreground,text etc. are user-definable. Just press the right mouse button
- Zoom-Feature: Press 'Shift' and draw the interesting region with the left mouse button pressed. 'Span' for the EB200 is automatically adjusted
- Temporarily suspend receiver(s): Press 'Shift' and double-click the corresponding radio's window. Function is duplicated in 'Receiver->Suspend Receiver'. Toggle to resume
- Interactive squelch: with the EB200 squelchlevel is displayed graphically and may also be set
- Click with the right mouse-button in the small radio windows displays a window for direct frequency entry

# VisualRadio Blackbird

is a Windows software for controlling the RFSpace SDR-14™. Includes spectra and waterfall, currently does not demodulate but adds

- Digital Scan
- Smooth Interaction with VisualRadio Falcon to store Frequencies, Dates, Times to the Falcons various tables for later retrieval
- Filter the tables by means of SQL statements: When were signals active in a certain range? What were their signal levels?...
- A mouseclick on an entry in the tables will tune the corresponding receiver to the stored Frequencies, including all parameters like mode, bandwidth etc.
- Will also store complete scenarios to disk for later playback
- Client/Server contained in one software package
- Displays all relevant parameters in clearly readable windows

[More Information](#)

- Index
- 600x800 resolution 12
- Agc 40
- All Devices 12
- Analogdisplay 41
- Audio Server 50
- Bfo 40
- Blk 40
- Channelscanvalues 6
- Channeltable 6
- Configure...** 15
- Cubic
  - AGC Attack Time 40
  - AGC Decay Time 40
- CUBIC DF-4409 19
- current active table 24
- dBm 41
- dBmV 41
- Delphin Systems MD403 19
- Deploying Parameters (HTML) 51
- Dynamic IP 51
- Example Write frequencies found to a table 43
- Features** 5
- Find Station** 21
- Find/Replace 7, 24
- Functions' Panel 13
- Insert Field 25
- Installation and Quick Start 7
- License Agreement** 4
- Linking Devices to WAN/ LAN / INTERNET 49
- Max 41
- Memorytable 6
- Microsoft Access 5
- Mode 40
- Mode Parameter (HTML) 52
- Notch 40
- Pbt 40
- Peak 41
- Receiver Settings 40
- Recorder 37
- Recording 37
- RMS 41
- Save to All Tables 25
- Save to Table 25
- Scan Functions** 35
- Scan Modes** 36
- Scan Modifiers** 35
- Scan Types** 36
- Scaninclude** 37
- Scantable Indicator 36
- Searching 33, 35
- Sectorscanvalues 6
- Sectortable 6
- Sessiontable Indicator 36
- Signal display 41
- Signal Units** 15
- Sorting 23
- Soundcard** 37
- Sql 40
- SQL-Server 5
- Squelch Parameter (HTML) 52
- Structure of the database 22
- S-Units 41
- System Requirements** 6
- Tables 6
- TCP/IP Command Set 53
- TCP/IP Panel 13
- The Database** 6
- Toolbar 13
- Upgrades 2
- Valuetable Indicator 36
- VisualRadio Basic. 5
- Width 40
- Width Parameter (HTML) 52